



350kg Magnetic Lock Manual

Specification

Model	Size(unit:mm)	Voltage	Current	Holding Force	Signal Output	Door
YM-350	285Lx49Wx28H	12/24VDC	12V/480mA 24V/240mA	350kg(800Lbs)	No	Single Door
YM-350D	570Lx49Wx28H	12/24VDC	12V/480mAx2 24V/240mAx2	350kgx2(800Lbsx2)	No	Double Door
YM-350(LED)	285Lx49Wx28H	12/24VDC	12V/480mA 24V/240mA	350kg(800Lbs)	Yes	Single Door
YM-350D(LED)	570Lx49Wx28H	12/24VDC	12V/480mAx2 24V/240mAx2	350kgx2(800Lbsx2)	Yes	Double Door
YM-350T(LED)	285Lx49Wx28H	12/24VDC	12V/480mA 24V/240mA	350kg(800Lbs)	Yes	Single Door
YM-350TD(LED)	570Lx49Wx28H	12/24VDC	12V/480mAx2 24V/240mAx2	350kgx2(800Lbsx2)	Yes	Double Door
YM-350BZ	285Lx49Wx28H	12/24VDC	12V/480mA 24V/240mA	350kg(800Lbs)	Yes	Single Door
YM-350DBZ	570Lx49Wx28H	12/24VDC	12V/480mAx2 24V/240mAx2	350kgx2(800Lbsx2)	Yes	Double Door

Diagram(unit:mm)

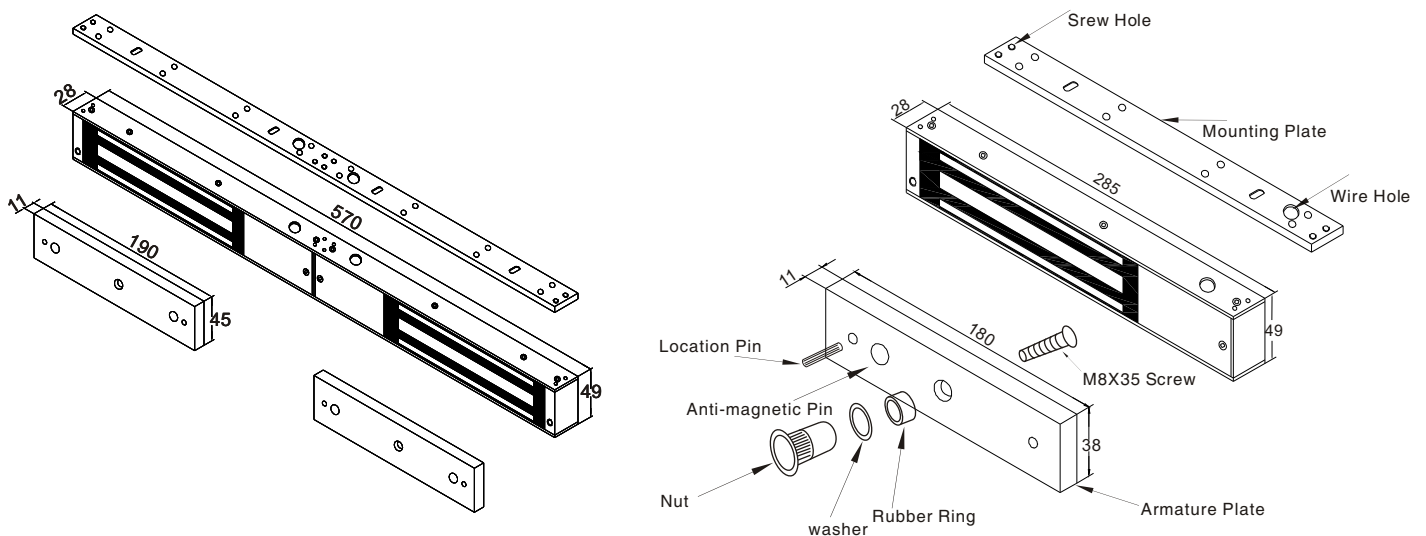

⚠ Remark:

A: Please Don't Fix The Screw(screw of Armature Plate) Tightly,
Let The Rubber Ring Maintain Proper Elasticity.

B: Please Check The Jumper Position, to Know Voltage is 12VDC or 24VDC.



350kg Magnetic Lock

Installation

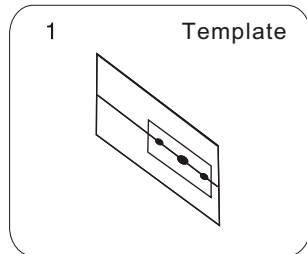
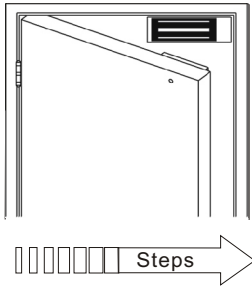

Flod the template to 90°

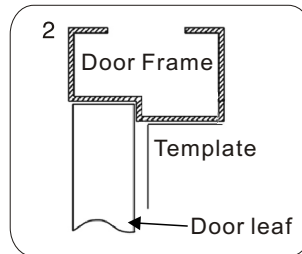

Close the door, place the template on door frame, close to door leaf.

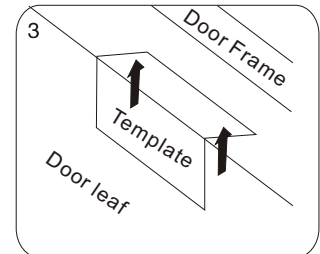

Mark screw positions on door leaf and door frame.

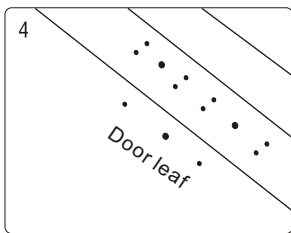

Drill holes on the marked positions

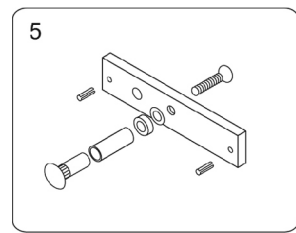

Install the Armature Plate on door leaf

Hollow Matel Door

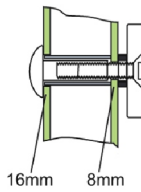

Drill a hole
Inside: Diameter is 8mm
Outside: Diameter is 16mm

Wooden Door

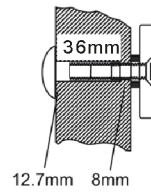

Drill a hole
Inside: Diameter is 8mm
Outside: Diameter is 12.7mm

Matel Surface Door

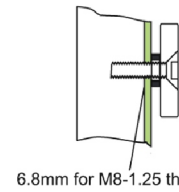

Inside: Drill a hole diameter is 8mm folding the plastic straight pin

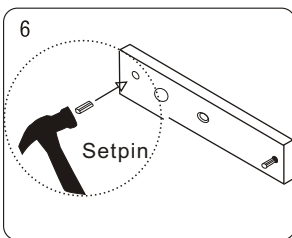

Put the pin into the Armature Plate.

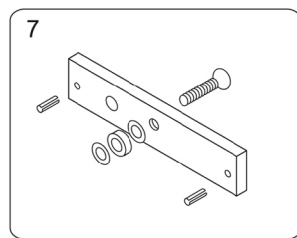

According to the picture add the washers on the Armature Plate.

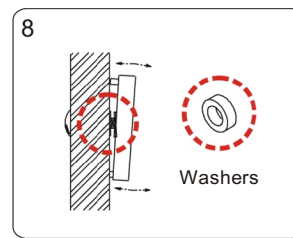

Plase washers between Armature plate and door leaf

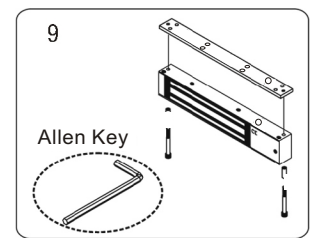

Use Allen Key to remove the Mounting plate from lock body

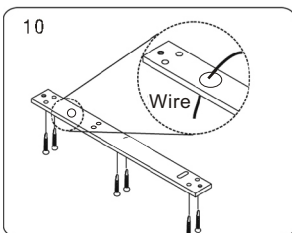

Wire go through the wire hole, then screw the mounting plate on top of the door frame.

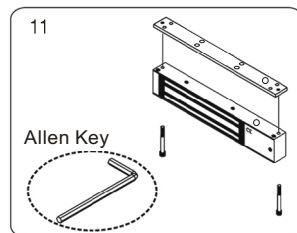

Use Allen Key to screw the lock body on the mounting plate.

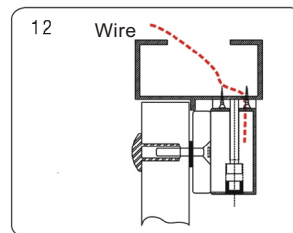

Close and pull the door to test holding force, extra washers can be added to adjust anfle between door leaf and armature plate.

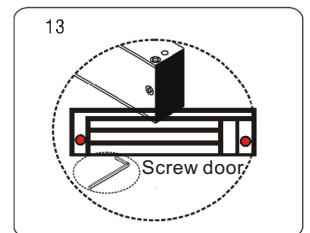

Confirm the holding force and tighten the proof screws



350kg Magnetic Lock

Bracket Installation

Different brackets are available according to different types of doors. For example, narrow door frame door, frameless glass door and inward opening door.

L Bracket

When the door frame thickness is less than 42mm, need to install the L bracket.

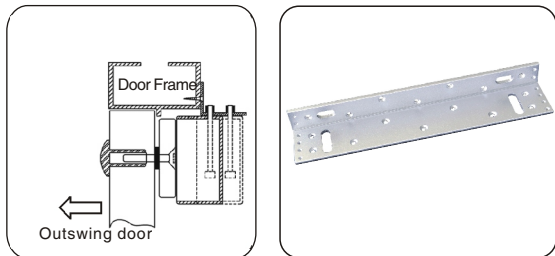

ZL Bracket

For inward opening door, need to install the ZL bracket.

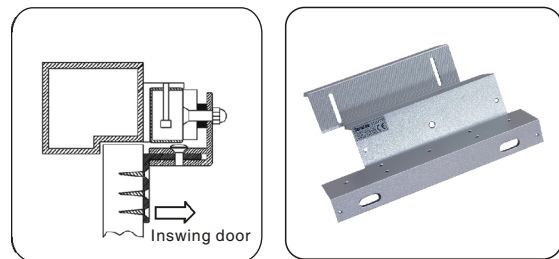

U Bracket

For the frameless glass door, need to install the UL bracket.
(suitable for 10-15mm glassdoor).

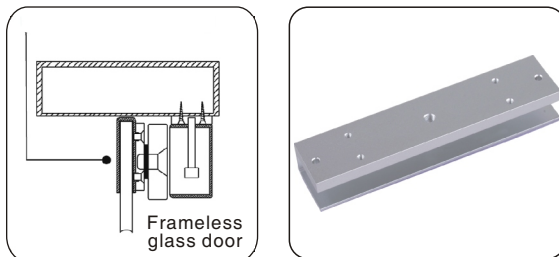

Bracket for Amature Plate

When the door frame is too thick, need to install the I bracket.

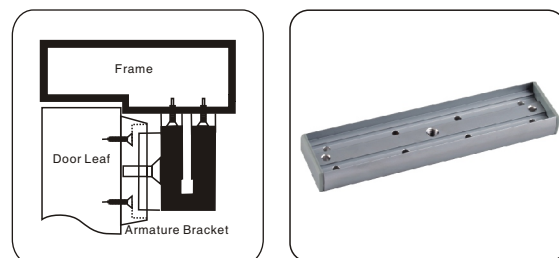

Installation Instruction

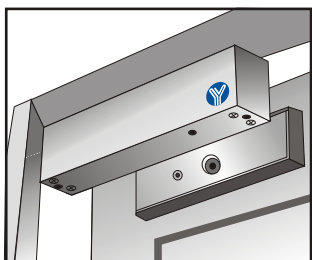

I Bracket Installation

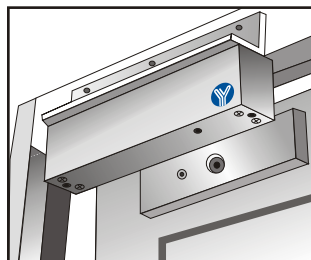

L Bracket Installation

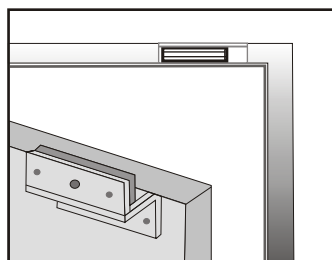

ZL Bracket Installation

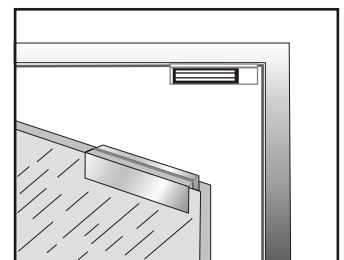

UL Bracket Installation



350kg Magnetic Lock

Circuit Board Diagram

A. 12VDC Input:
 Required power 0.48Amp(Minimum).
 Connect the positive(+)lead from a 12VDC power source to V +.
 Connect the ground(-)lead from a 12VDC power source to V -.
 Check jumper for 12 VDC operation.

B. 24VDC Input:
 Required power 0.24Amp(Minimum).
 Connect the positive(+)lead from a 24VDC power source to V +.
 Connect the ground(-)lead from a 24VDC power source to V -.
 Check jumper for 24 VDC operation.

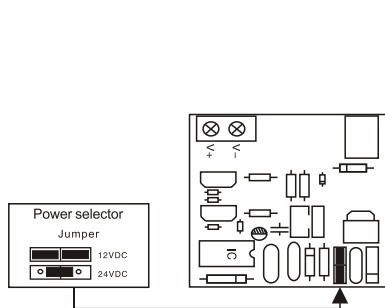

YM-350, YM-350D

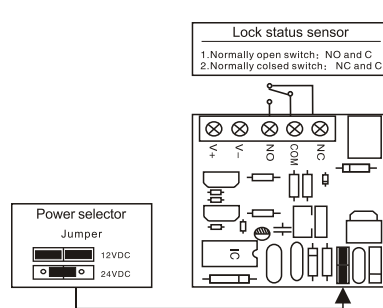

YM-350(LED), YM-350D(LED)

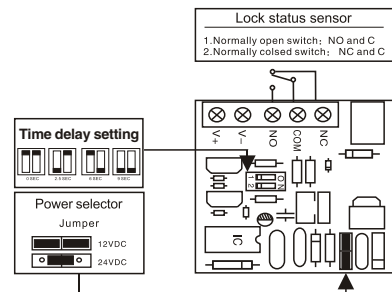

YM-350T(LED), YM-350TD(LED)

Wire Connection

